

JEE-0<sup>®</sup>

THE **INDOOR**  
BATHROOM COLLECTION

*Design your indoors*



Cone shower 02 gun metal, Hotel Abdij Dokkum, the Netherlands.

## OUR STORY

The story of JEE-O began with a single, bold idea: the freestanding shower.

A design so pure, so functional and so distinctive that it became the foundation of everything JEE-O stands for today. Founded in the Netherlands, JEE-O was built on the belief that a bathroom is more than a functional space. It is a place to recharge. A personal sanctuary where water, design and wellbeing come together.

Collaboration is at the heart of our design philosophy. By partnering with nationally and internationally renowned designers, we create signature series that elevate both form and function. These collaborations infuse each collection with a unique identity, reinforcing JEE-O's position as a recognisable and leading design brand on the global stage.

*From a bold idea to  
a global design brand.*

Today, JEE-O collections are used in private homes, hotels, resorts, retail environments and architectural projects in more than 50 countries worldwide. From boutique hotels to global hospitality chains. From outdoor spaces to refined indoor interiors. Despite this global growth, the DNA of JEE-O has never changed.

The focus remains on powerful yet minimalist design, functional innovation and an uncompromising aesthetic. By continuously exploring new technologies, materials and applications, JEE-O keeps redefining how water is experienced, both indoors and outdoors.

**That's how we create everlasting icons.**



## THE CRAFTSMANSHIP OF JEE-O

At JEE-O, craftsmanship is more than a process. It is a philosophy. Every product is created with uncompromising attention to detail, a relentless pursuit of perfection and a clear focus on quality. You see it in the design. You feel it in use.

At a time when longevity matters more than ever, JEE-O designs are built to last a lifetime. Durability is not an option. It is a promise.

*Lives in  
The finishing.*

High-grade stainless steel forms the foundation of our collections. Chosen for its strength, purity and ease of maintenance, it ensures lasting performance, both indoors and outdoors. Yet true craftsmanship goes beyond materials alone.

*It lives in the finishing.*

*In the balance of proportions.*

*In the final hand-polished detail that makes each piece unique.*

JEE-O challenges what is possible in both design and functionality. Our products are not just utilities; they are statement pieces that merge bold aesthetics with exceptional performance. Every curve, every texture and every interaction is carefully considered to create a truly luxurious experience.

**That is craftsmanship. That is JEE-O.**

## QUALITY STARTS WITH THE MATERIAL

At JEE-O, material choice is never an afterthought. It is a design decision that defines the look, the feel and the longevity of every product. That is why our collections are made from high-grade stainless steel. Fully. Inside and out.

Both the visible and concealed parts of our tapware are crafted from stainless steel, resulting in products that are exceptionally robust, durable and reliable. No compromises. No shortcuts. Stainless steel feels cool and solid to the touch. It offers a sense of precision you experience every time you open the tap.

**Real materials create real impact.**

In quality. In experience. In time.

**That is why JEE-O designs are built to perform, crafted to last and designed to be felt.**



*Real materials.  
Real impact.*

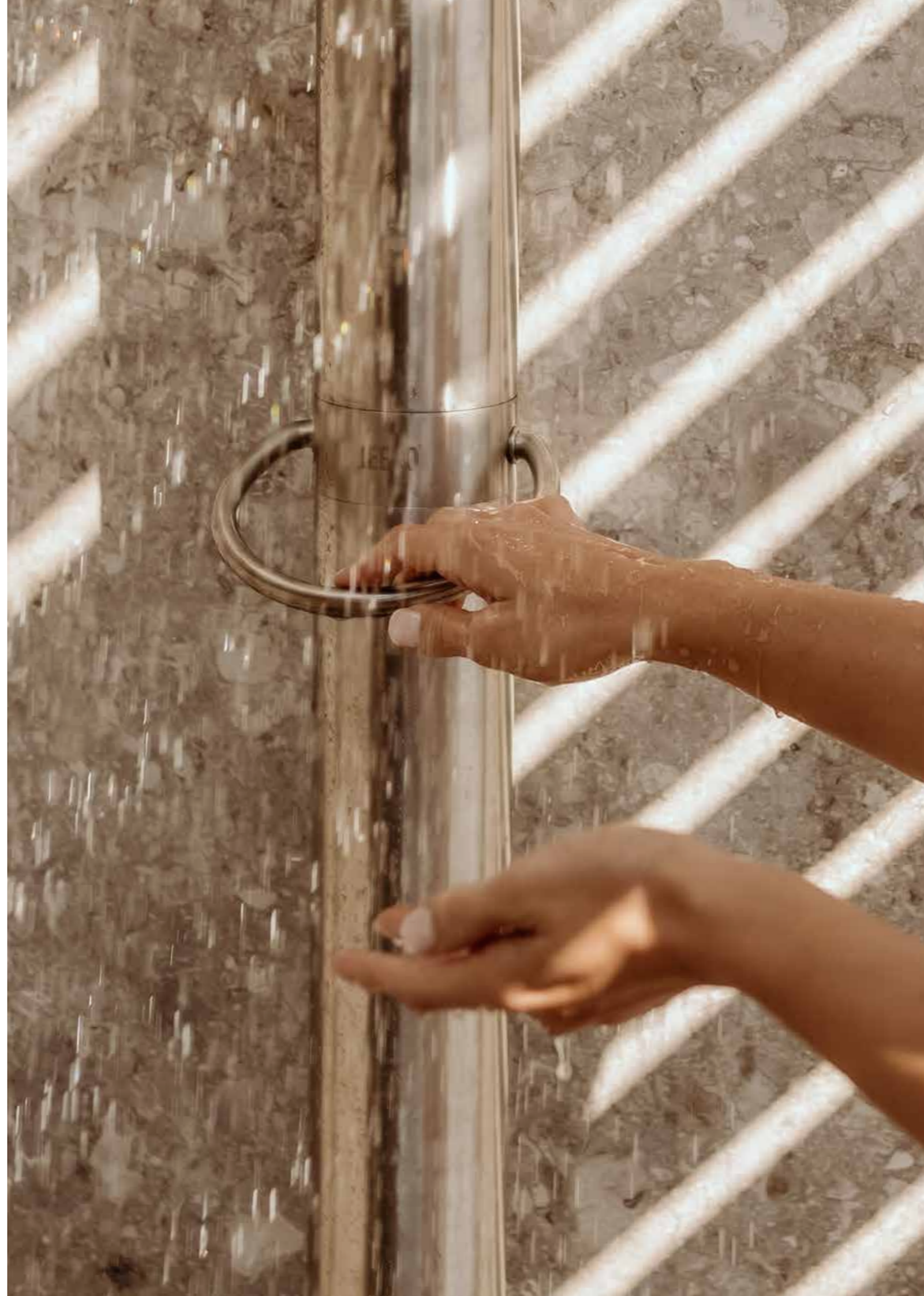

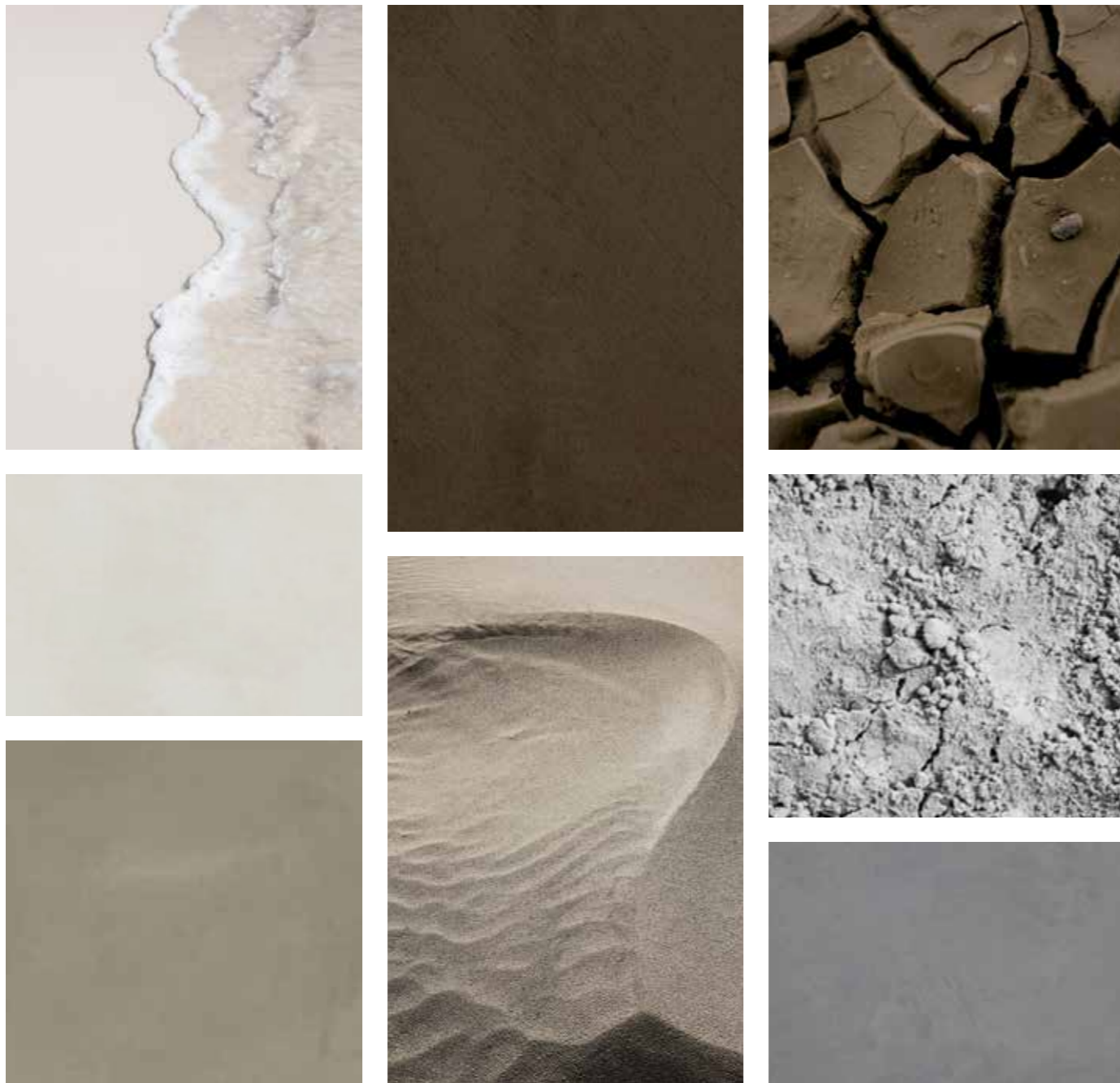

## DADO BY JEE-O

DADOquartz is JEE-O's signature material for baths and basins. A high-quality solid surface and consistently coloured material, that combines refined aesthetics with outstanding performance.

Lightweight yet strong, DADOquartz allows for sculptural forms without compromising durability. The material feels soft and warm to the touch, creating a comfortable, natural bathing experience from the first moment.

DADOquartz is seamless, non-porous and easy to maintain. It has a consistent material structure through and through. Built for everyday use and designed to last a lifetime. That's why every DADO bath and basin comes with a lifetime warranty.

**Pure in appearance. Solid colours.**



### **DADOquartz**

Solid new colours  
Light weight material  
25 years warranty  
Soft warm touch



Scan to explore the full  
DADO design collection  
**We inspire**



*Our first model,  
pretty cool.*



Original shower 01 brushed, Massimo Villabouw, Belgium.

## THE ORIGINAL - HOW IT STARTED

JEE-O's journey to becoming a global design brand, started with a single, bold idea: the original freestanding shower. A design so striking, so functional, and so pure in its form that it became the foundation of everything JEE-O stands for today.

At the heart of its design lies simplicity. The graceful, curved stainless steel pipe forms an inverted J, while the distinctive circular control handle – the O – provides effortless operation. This perfect balance of form and function is what makes the original shower, a true statement piece.

Designed for both indoor and outdoor use, the original redefines the shower experience. Whether positioned by a pool, in a garden or within a refined indoor bathroom, its presence feels both bold and elegant. Crafted from high-quality brushed stainless steel, it is built to withstand the elements while retaining its timeless appeal.

Yet the original is more than just a design icon. It embodies the JEE-O philosophy. A belief in freedom, simplicity, and an energising experience. It marked the first step in a journey that transformed JEE-O from a pioneering Dutch label into an internationally recognised design force. Even today, the original remains a true classic, proving that great design never fades. It continues to inspire.

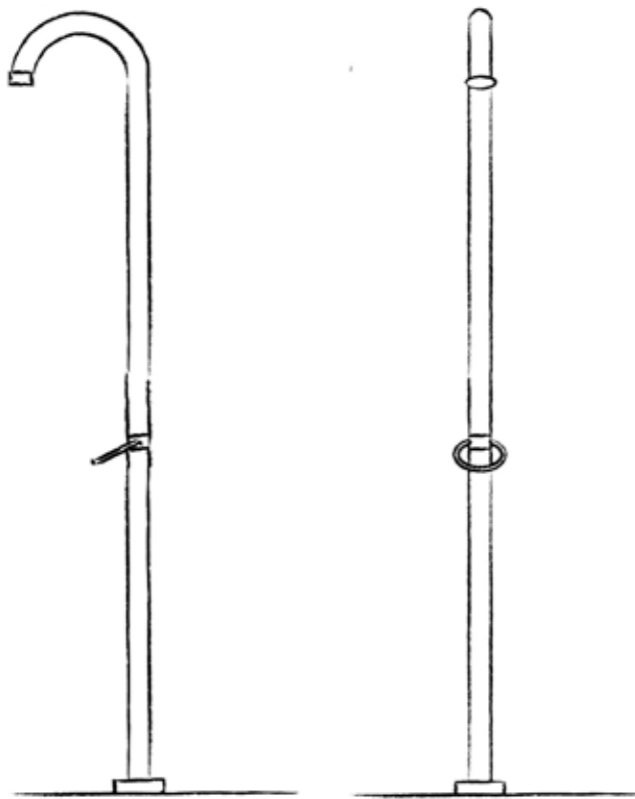

Scan to explore the  
full original series  
**We inspire**



# CONE

Characterized by its perfect balance of playfulness and presence, the cone series is a statement in contemporary design. Every detail is expertly crafted, from its flowing contours to its high-end finish, making it not just a functional element but a sculptural piece that enhances any space.

Designed in collaboration with renowned designer Osiris Hertman, the cone series seamlessly merges timeless aesthetics with contemporary craftsmanship. It embodies both sophistication and innovation.

The freestanding cone shower blends effortlessly into high-end spaces – indoors or out – where its sculptural form and refined simplicity elevate the environment. With its minimalist yet striking presence, cone brings a sense of serenity and calm elegance to any setting.

The partnership between JEE-O founder Lammert Moerman and Osiris Hertman reflects the power of collaboration in design. Their shared vision, creativity and expertise, resulted in a collection that redefines modern luxury. Cone is more than just a shower. It is an experience – a celebration of pure design and ultimate comfort.

**Designed by Osiris Hertman.**

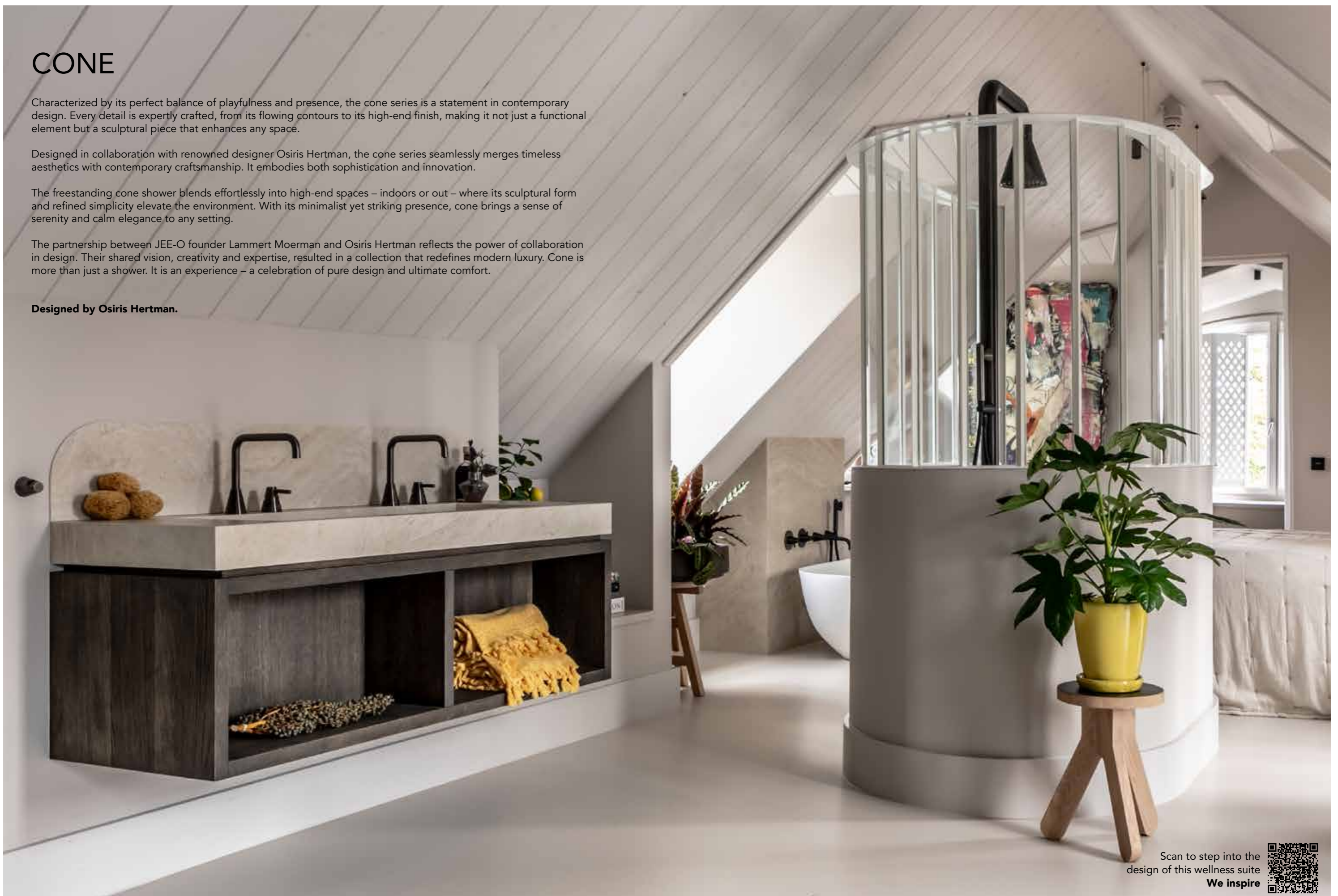

Scan to step into the  
design of this wellness suite  
**We inspire**





## PLACE TO RECHARGE

For Osiris Hertman, designer of the JEE-O cone series, craftsmanship is central to his designs. He believes that, while water should be used with care, it should also be enjoyed. Our bathrooms are gradually becoming spaces of relaxation, enriched with seats, music, plants, and where space admits – saunas, fireplaces and stunning views.

They are now places to recharge so we can deal with a world that feels more fast-paced and demanding.

The conical shape, the basis for this series, is expressed in the smallest details. The handles are modelled on safe doors – after all, water is a precious resource. At the same time, the designs bring allure to your home.

*Masterpiece of elegance  
and precision.*



Scan to explore the  
full cone series  
**We inspire**

*So easy to  
handle.*



Soho basin mixer RAW, Harbor gym, the Netherlands.

*From vision to  
design icon.*

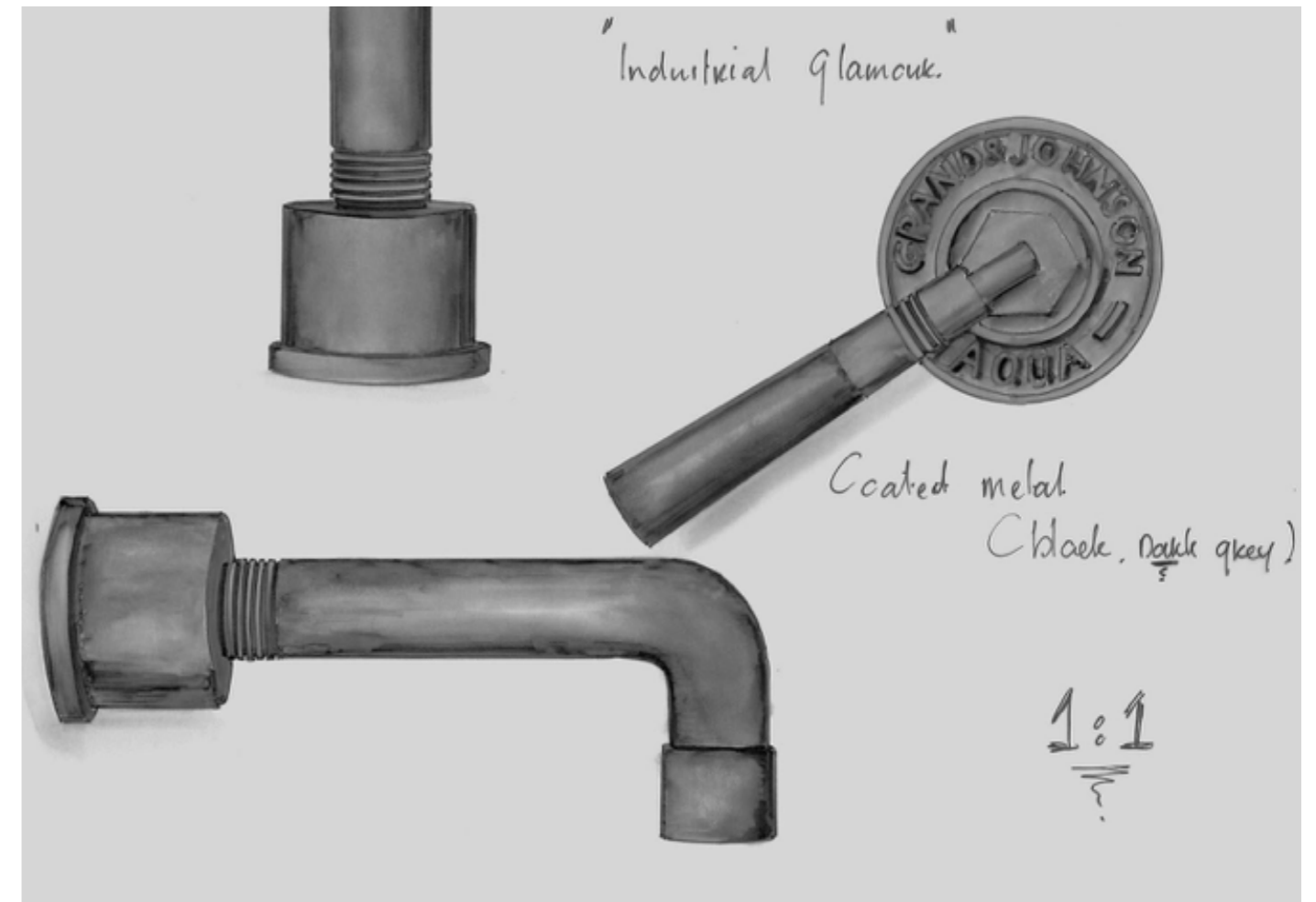

## SOHO

It all started with a simple yet powerful idea. The Amsterdam-based design duo Grand & Johnson envisioned a freestanding shower inspired by the raw beauty of industrial pipes and tubes. Their initial sketches formed the blueprint for what would evolve into an iconic design. But to bring their vision to life, they needed a partner with the expertise and craftsmanship to make it a reality.

That partner was JEE-O. Recognised for its authority in freestanding outdoor and indoor showers, JEE-O immediately saw the potential of this striking concept. During a trip to New York, founder Lammert Moerman explored the vibrant streets of SoHo – a district known for its industrial lofts, raw architecture and creative energy. The parallels between the neighbourhood's bold, stripped-back aesthetic and the design vision of Grand & Johnson were unmistakable. It was here that everything came together, inspiring not only the final design direction, but also the name of the collection: soho.

The JEE-O soho shower is the perfect embodiment of "less is more". Crafted from stainless steel and finished with a durable all-weather hammercoating, it has a raw, industrial appeal. The signature one-move cartridge technology allows for seamless operation, with a tactile joystick handle offering intuitive control. Strong, striking, and stylish – the soho shower is more than just a functional object; it's a statement piece.

**Designed by Grand & Johnson.**

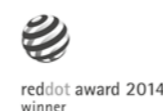

Scan to explore the  
full soho series  
**We inspire**



## ENHANCE DAILY EXPERIENCE

The pure series is a refined expression of balance, simplicity and sensory experience. Inspired by Asian aesthetics, the collection brings a sense of calm, harmony and understated luxury to the bathroom.

At the heart of the design is the iconic ring, a distinctive and intuitive element that controls both water flow and temperature. This signature feature not only defines the look of the series, but also enhances the interaction between user and product.

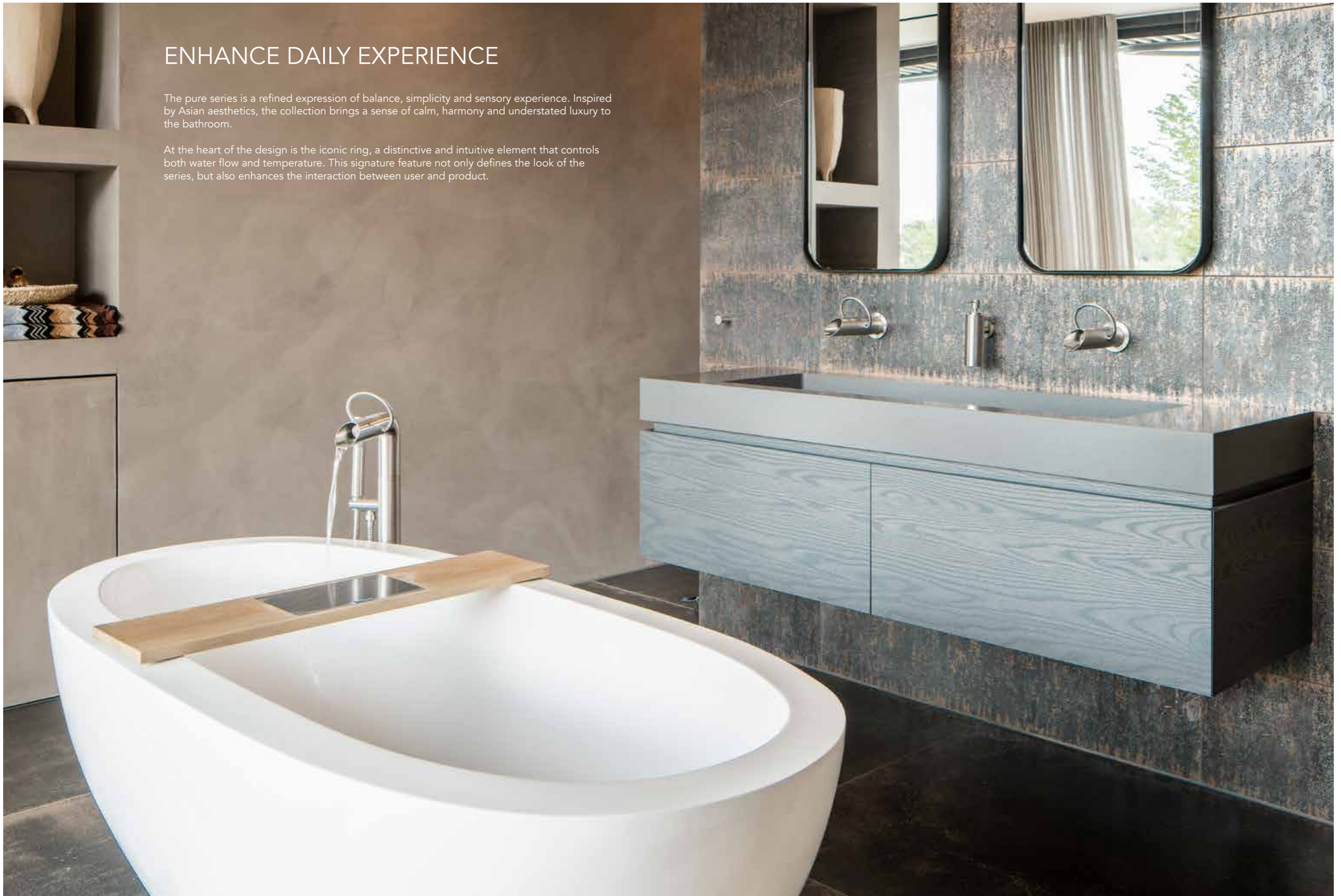

Pure bath mixer and wall basin mixer brushed, Moloko bath made from DADOquartz, Villa W, the Netherlands.



## PURE

Pure is the embodiment of water in its most essential form. As water flows effortlessly from the spout, it captures and reflects light, creating a dynamic and almost meditative experience. It's not just about functionality – it's about feeling. A moment of tranquillity, energy and connection.

The collection includes freestanding showers, bath mixers, and both wall- and top-mounted taps, offering complete design freedom for a cohesive bathroom concept.

The pure series is also featured worldwide in selected Rituals shops, where its serene aesthetic perfectly complements the brand's philosophy of wellbeing and relaxation.

*Iconic, minimalist design.  
Signature JEE-O ring for intuitive control.  
Featured in Rituals shops worldwide.*

Designer Lammert Moerman says: "With our freestanding icons, we aim to give people the freedom to design a bathroom that truly enhances their daily experience."

**Designed by Lammert Moerman.**

Scan to explore the  
full pure series  
**We inspire**



*Stripped to the  
essential.*



Slimline series brushed, private villa Ibiza, Spain.



## SLIMLINE

Slimline is not just a collection, it is a complete bathroom concept. A system built on clarity and cohesion, offering the freedom to design an entire space in one consistent architectural language. From showers and taps to baths, basins and even accessories, each element is part of a larger composition. Nothing feels added. Everything feels intentional.

At the heart of slimline lies its signature: ultra-refined proportions. Lines are slender, yet confident. Forms are reduced to their essence, without ever becoming fragile. There is strength in this simplicity, a balance between precision engineering and tactile presence. Stainless steel, executed with care, gives the series its unmistakable weight and durability.

Materiality plays a defining role. Slimline is available in brushed stainless steel, structured black, bronze, gold matt and dark steel. Each finish lends its own atmosphere to the space. Structured black introduces depth through texture, while brushed steel remains timeless and understated. Bronze and gold matt add warmth, catching light in a softer, more sensual way. Dark steel, in contrast, leans into a bold, architectural in presence.

The result is a series that adapts effortlessly without losing identity.

Slimline thrives in environments where architecture leads. It elevates its surroundings. Like a **perfectly framed drawn line**, it defines exactly what is needed and nothing more.

In a world that often adds more, slimline proves the power of restraint. A bathroom, reduced to its purest form.

### The art of reduction



Scan to explore the full slimline series  
**We inspire**

*From hidden flow  
to visible form.*



Flow bath mixer brushed, Tulip bath made from DADOquartz, Capri, Italy.



## FLOW

Water takes on the shape of the object that contains it. That idea has been the starting point for Italian designer Brian Sironi in creating the JEE-O flow series. Up until the moment water flows from the faucet and is free to take on any shape, it has the shape of the pipes through which it flows. Brian Sironi: "We rarely see the pipes; they are hidden behind walls and beneath floors. These taps and mixers from the flow series reveal the piping, extending it into the bathroom."

The result is a collection that reveals an often unseen element of architecture, transforming it into a defining design feature. Flow expresses structure, movement and water in their purest relationship.

**Designed by Brian Sironi.**

*Out of sight.  
Built to perform.*



Scan to explore the  
full flow series  
**We inspire**

*A fusion of nature  
and geometry.*

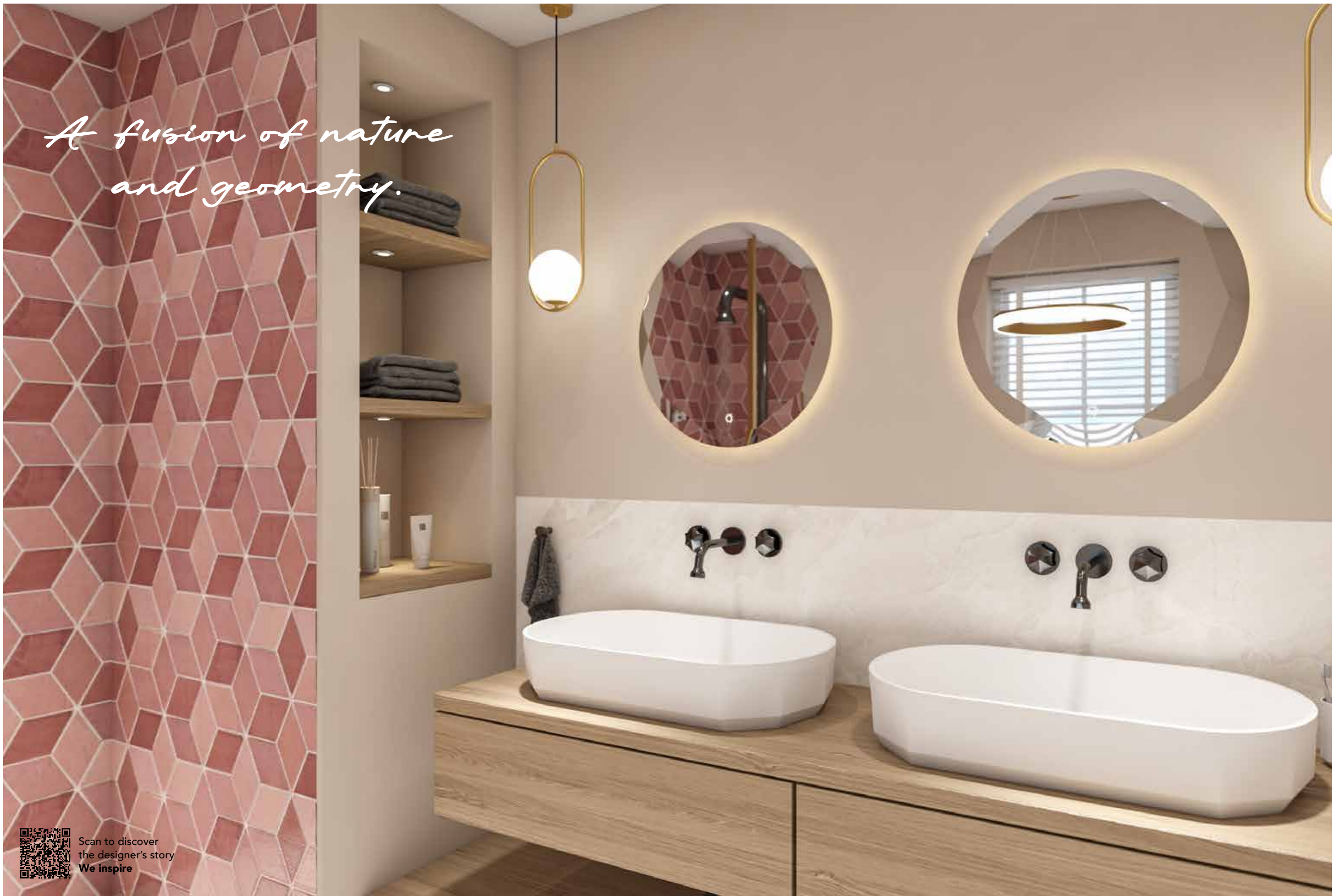

Scan to discover  
the designer's story  
**We inspire**

Bloom wall basin mixer gun metal, oval basin DADOquartz, Copenhagen, Denmark.



## BLOOM

The bloom series is the result of a remarkable collaboration between JEE-O and renowned Dutch designer Edward van Vliet. This collection brings Van Vliet's passion for nature and geometry to life in a refined bathroom series with striking character and elegance.

The partnership began in 2016. From a shared vision, a collection emerged that unites JEE-O's industrial minimalism with Van Vliet's more playful, organic design language. The result? A series that feels both expressive and elegant.

*The shape of  
a sunflower.*

A defining piece is the freestanding bloom shower, inspired by the shape of a sunflower. With its hexagonal shower head and smooth transition from faceted to rounded forms, the design reflects the harmony and elegance found in nature. This design language is expressed throughout the bloom series, from basins and baths to mirrors.

Crafted from high-quality materials, the bloom series is more than just functional. It is a timeless statement of luxury and sophistication.

**Designed by Edward van Vliet.**

Scan to explore the  
full bloom series  
**We inspire**



*Powerful design  
for every space.*



Fatline shower push brushed, Casa Medusa Carvoeiro, Portugal.



## FATLINE

The JEE-O fatline series is designed as a statement. Defined by its generous proportions and powerful simplicity, it transforms the shower into an architectural object rather than a purely functional element.

With its distinctive, full-bodied silhouette and wide overhead spray, fatline offers a rich and immersive water experience. Crafted from high-quality stainless steel and suitable for both indoor and outdoor use, it combines durability with a refined, timeless aesthetic.

*Bold by nature.*

Fatline feels most at home where architecture meets nature. Beside a pool, in a landscaped garden or as part of a spa-like bathroom, it creates a seamless connection between inside and outside. A place where water, space and surroundings come together.

Uncompromising in presence, yet pure in design, fatline does not blend in – it defines its environment.

**A powerful expression of form, function and freedom.**

Scan to explore the  
full fatline series  
**We inspire**





## TOILET

Often, this space is not the first priority when designing an interior. Yet with the design items from JEE-O, it only takes a subtle intervention to elevate this private moment.

Comfort and hygiene are essential when selecting products and materials. The JEE-O toilet series proves that functionality and design can go hand in hand, with the JEE-O base as the refined finishing touch.

As space is often limited, smart design becomes key. The base combines effortlessly with the flow or amsterdam small basin and is available in various finishes. Three elegant combination sets offer flexibility, with the option of a cut-out on the left, right or centre. This ensures a natural fit in any layout, positioning the basin exactly where it feels most intuitive. If desired, there is space for a soap dispenser on top, while each base features a subtle, integrated rail underneath for a towel.

The different finishes of the slimline wall-mounted tap, basin waste and siphon allow each toilet space to be styled with its own character. A compact space, thoughtfully designed; where every detail matters.

**Small space, big impact.**

*Take a seat.*



*Clean by nature  
powered by sensors.*

## TOUCHLESS DESIGN

Introducing the touchless designs of the JEE-O wall mounted basin mixers. Thanks to infrared sensor technology, our beautiful wall mounted basin mixers can now be operated without a touch. Experience the magic of this high-tech innovation. It not only makes life easier, but also supports more responsible water use. Thanks to the automatic activation, water flow for as long as it is actually necessary. Hygienic and water efficient.

The JEE-O sensor taps make the refined elegance of a stunning design available for public spaces. This allows restaurants, hotels, wellness spas, museums, clubs and all other public spaces to provide their visitors with a design that fits their exclusive and modern appearance. The purity of design is preserved, remaining free from fingerprints contributing to a clearer environment.

All our sensors come with reliable infrared technology. This once again demonstrates that design and functionality can exist in harmony. Each serie can be combined effortlessly, there is no need to compromise on interior design choices.

**The magic of no-touch technology.**

## BEAUTY OF FREESTANDING

Why limit the beauty of an outdoor shower to the garden, terrace, or poolside? At JEE-O, every shower series is designed for both outdoor and indoor use, offering endless possibilities to transform your home. A freestanding shower indoors is more than just a functional element. It is a statement piece that introduces a sense of serenity, nature, and luxury into your interior.

Placed near a generous window or in an open-plan bathroom concept, a minimalist stainless steel shower creates a harmonious connection between indoors and outdoors. The natural light, the sight of greenery, and the soothing sound of water turn a daily routine into a moment of escape.

*Bringing the  
outdoors in.*

Each JEE-O series includes matching accessories, taps and basins, allowing you to create a cohesive, beautifully designed space. Whether you prefer the bold lines of the soho series, the organic elegance of bloom, or the powerful simplicity of fatline, a freestanding shower indoors introduces a new dimension to contemporary living.

Turn your indoor space into a sanctuary, where water, nature and design come together in perfect balance.



## BRING IT OUTDOOR

Wellness is increasingly moving outdoors. Not only as a refreshing moment after a sauna session, but as a complete relaxation experience in nature. Inspired by this shift, more and more people are relocating a shower, and sometimes even a bath, into the garden or roof terrace. It brings together tranquillity, openness and experience.

With JEE-O's outdoor designs, showering outside becomes a daily wellness ritual, in which design and nature enhance one another. This is inside-out wellness in its purest form.

By moving the bathroom outside, a natural transition between indoors and outdoors is created. This connection makes the experience more intense and personal.



*Shower in the open,  
day and night.*

# EXPLORE OUR DESIGN STORIES

Go beyond the collection. From outdoor experiences to innovative concepts and collaborations, each publication reveals a different side of JEE-O. Step into our world through our magazines, brochures and design stories.

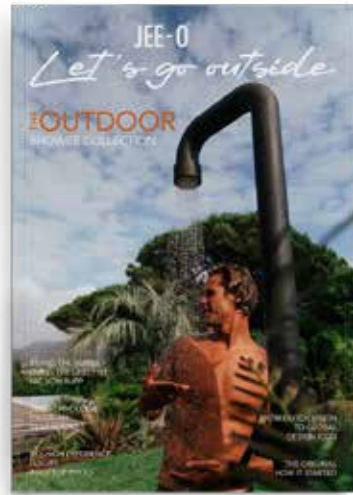

Outdoor magazine



Cone magazine



SlimTec by JEE-O



Toilet collection



Toucheless collection



Inspired by what you see? Experience JEE-O as it is meant to be. Scan the QR code to find a dealer near you and discover our designs. See, touch and feel the quality for yourself.

# COLOFON

**JEE-O indoor magazine**  
Edition: April 2026

**Publisher**  
JEE-O  
www.jee-o.com

**Editorial & Design**  
JEE-O Marketing & Communication

## Project & Photography

Studio Arte	Jules Web Studio	1
Hotel Abdij Dokkum	Laura Hage	2
Massimmo Villabouw	Marble Moon	10-11
Zilt Architecten	Hans Gorter, The art of living	13
Hotel Abdij Dokkum	Laura Hage	14-15
Ton Scholten	Nieke Fris Studio	16
Elize Wikkerink	Peter Baas	22-23
Daudi Concepts	Peter Baas, Excellent Magazine	28
Zakaria	Stone Company	29
Patricia Snoek	Patricia Snoek	32-33
Studio Arte, Georgia Vlieger	Zavial Studio	38-39
Hotel Abdij Dokkum	Laura Hage	43
Penthouse 14	Nick Decombel	48-49
Finished Forms the residence	Sanne Kaal	52

## Image Rights Disclaimer

Every effort has been made to trace and acknowledge the rightful copyright holders of all images featured in this publication. All images are used in good faith for illustrative and editorial purposes. If you believe that any image has been used without proper credit or authorization, please contact us at [info@jee-o.com](mailto:info@jee-o.com), and we will take immediate steps to rectify the situation. All trademarks, product names, and company names or logos cited in this magazine are the property of their respective owners.

## Materials

JEE-O works with carefully selected solid surface materials. Slight variations in the aesthetic appearance of the product including the colour, may occur after exposure to atmospheric influences such as sunlight, pollution or harmful chemicals. This does not affect the product performance in any manner. Situation specific care and maintenance instructions may apply. For our general cleaning and maintenance recommendations, visit our website [www.jee-o.com](http://www.jee-o.com)

The general conditions of JEE-O International bv shall be applicable to all our transactions. They can be found on our website. Prices and models are subject to change and may contain typographical errors.

JEE-O unique bathrooms - indoor collection 2026 © JEE-O all rights reserved  
JEE-O is a registered trademark of JEE-O Concepts B.V.

# JEE-0<sup>®</sup>



[www.jee-o.com](http://www.jee-o.com)



#jeeoworld @jeeoworld